



19 Inch Rear Mount PCAP Touch Monitor







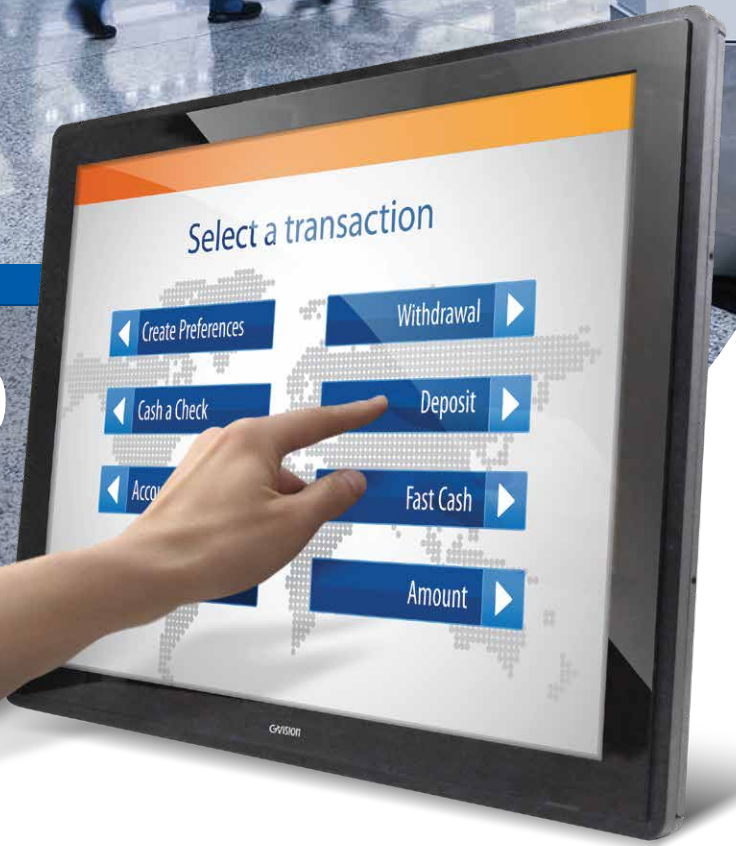

R19ZH-OV-45P0

REAR MOUNT

GVision's line of rear mount projected capacitive displays are purpose built for system builders who require a rugged and durable touch screen solution that can easily be integrated into any embedded application.

It is completely sealed to protect against the elements, which means it can be used either inside or out, and in high-traffic public facing applications.



- 
 10-Points Touch
- 
 DVI-D Digital Input
- 
 HDMI Digital Input
- 
 VGA Analog Input
- 
 USB B-Type Touch
- 
 IP65 Protected
- 
 LED Backlight Unit
- 
 3-Years Warranty

19" REAL MOUNT Projected Capacity



FEATURES

- 19-Inch Screen Size
- 1280 x 1024 Resolution
- Video signal: VGA / DVI / HDMI
- IP65 on the Front (Optional)
- Zero Pressure Touch Activation
- LED Backlight Unit
- Metal Enclosure Material

SPECIFICATIONS

INPUT INTERFACE



Multi Inputs

GVision's KISOK Open Frame monitor supports both digital and analog inputs to use as normal office desktop monitor with VGA, DVI input or HDMI for commercial digital signage as well.

DIMENSIONS

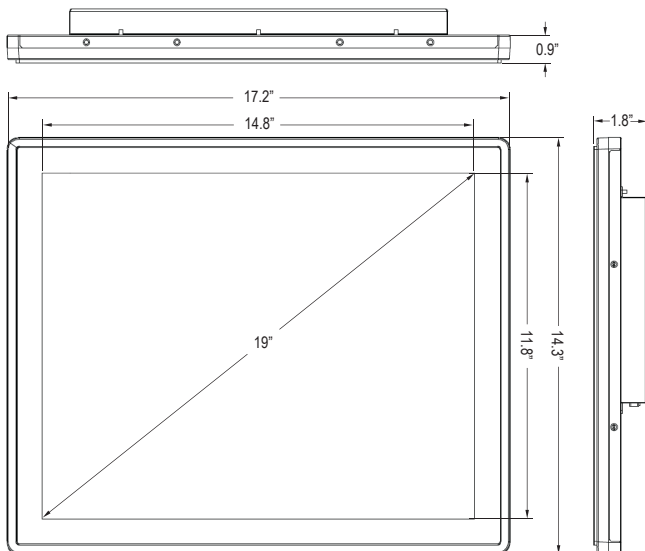

DISPLAY	R19ZH-OV-45P0
Screen Size	19 In
Resolution	1280 x 1024
Backlight	LED
Aspect Ratio	5 : 4
Viewing Angle	170° / 160°
Response Time	5ms
Brightness	250cd/m ²
Contrast Ratio	1000 : 1
Color Depth	16.7 M
Display Area (mm)	376.32 x 301.06mm
INTERFACE	
HDMI	1
DVI	1
VGA (15 Pin D-Sub)	1
USB (B-Type)	1
TOUCH TECHNOLOGY	
Touch Material	2 mm Glass
Touch Points / Type	10 Max / Projected Capacitive (PCAP)
Touch Accuracy	2 mm
AUDIO	
Speakers	Option
CABINET	
Material	Metal
POWER	
Consumption	20W Max Standby ≤ 0.5W
Electrical Ratings	12VDC ± 5% (Adapter Input AC 100V ~ 240V, 50/60Hz)
TEMPERATURE	
Operating	32° F ~ 104° F (0° C ~ 40° C)
Storage	-4° F ~ 140° F (-20° C ~ 60° C)
HUMIDITY	
Operating	20% ~ 80%
Storage	10% ~ 90%
DIMENSIONS (WxHxD)	
Inch (in)	17.2 x 14.3 x 1.8
Millimeter (mm)	438.9 x 363.7 x 47.0
WEIGHT	
Net Weight	11.0 lbs (5 kg)
VESA™	
Mount Size (mm)	100 x 100

Specifications subject to change without any notice