



USER MANUAL

Elo Touch Solutions PayPoint® Plus for Windows



Copyright © 2018 Elo Touch Solutions, Inc. All Rights Reserved.

No part of this publication may be reproduced, transmitted, transcribed, stored in a retrieval system, or translated into any language or computer language, in any form or by any means, including, but not limited to, electronic, magnetic, optical, chemical, manual, or otherwise without prior written permission of Elo Touch Solutions, Inc.

Disclaimer

The information in this document is subject to change without notice. Elo Touch Solutions, Inc. and its Affiliates (collectively "Elo") makes no representations or warranties with respect to the contents herein, and specifically disclaims any implied warranties of merchantability or fitness for a particular purpose. Elo reserves the right to

Revise this publication and to make changes from time to time in the content hereof without obligation of Elo to notify any person of such revisions or changes.

Trademark Acknowledgments

Elo, Elo (logo), Elo Touch, Elo Touch Solutions and PayPoint, are trademarks of Elo and its Affiliates.

Table of Contents

Section 1: Introduction 4

Section 2: Unpacking and Operation 5

Section 3: Receipt Printer 17

Section 4: Barcode Scanner 22

Section 5: Technical Support and Maintenance 29

Section 6: Regulatory Information 32

Section 7: Warranty Information 40

Section 1: Introduction

Product Description

The Elo PayPoint Plus register is an all-in-one Wintel based cash register that comes equipped with built-in receipt printer, magnetic stripe reader, barcode reader, and cash drawer. In addition to its built-in peripherals, the system has USB, Serial, and HDMI ports that allow for connectivity of external devices.

Precautions

Follow all warnings, precautions and maintenance as recommended in this user manual to maximize the life of your unit and prevent risks to user safety. See Section 6 for more information on safety.

This manual contains information that is important to ensure proper setup of the PayPoint Plus. Before setting up and powering on your PayPoint Plus, read through this manual, especially Unpacking and Operation, and Technical Support and Maintenance sections.

Section 2: Unpacking and Operation

Box Contents

Verify that the box contains:

- PayPoint Plus for Windows
- Quick Install Guide
- Power Cable
- 1x receipt paper roll
- 2x cash drawer keys
- 1x RJ45 to DB9 Serial Cable

Elo PayPoint Plus Layout

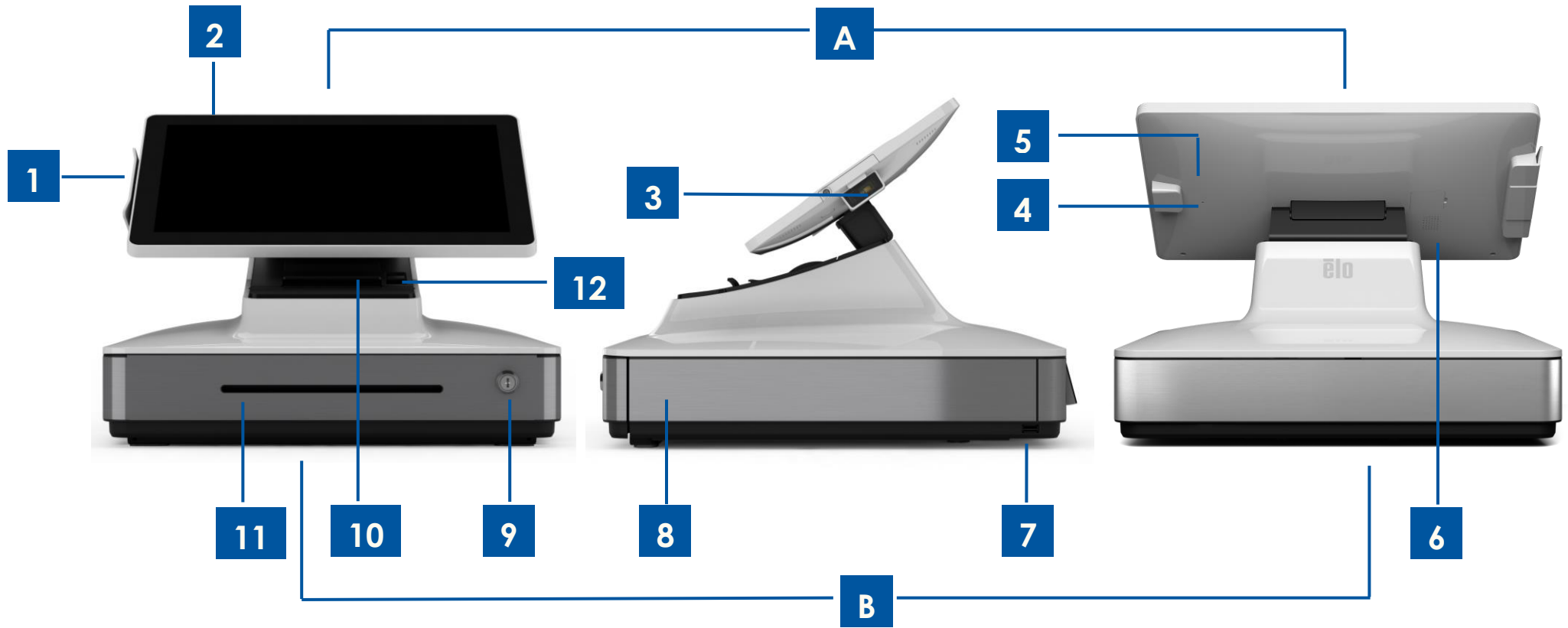

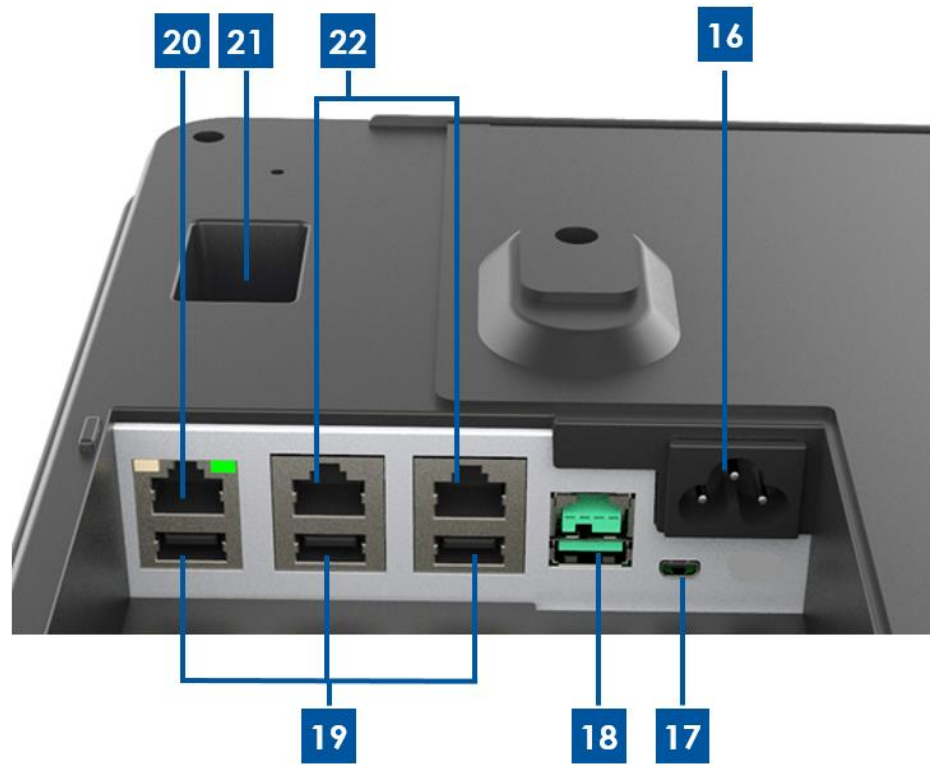
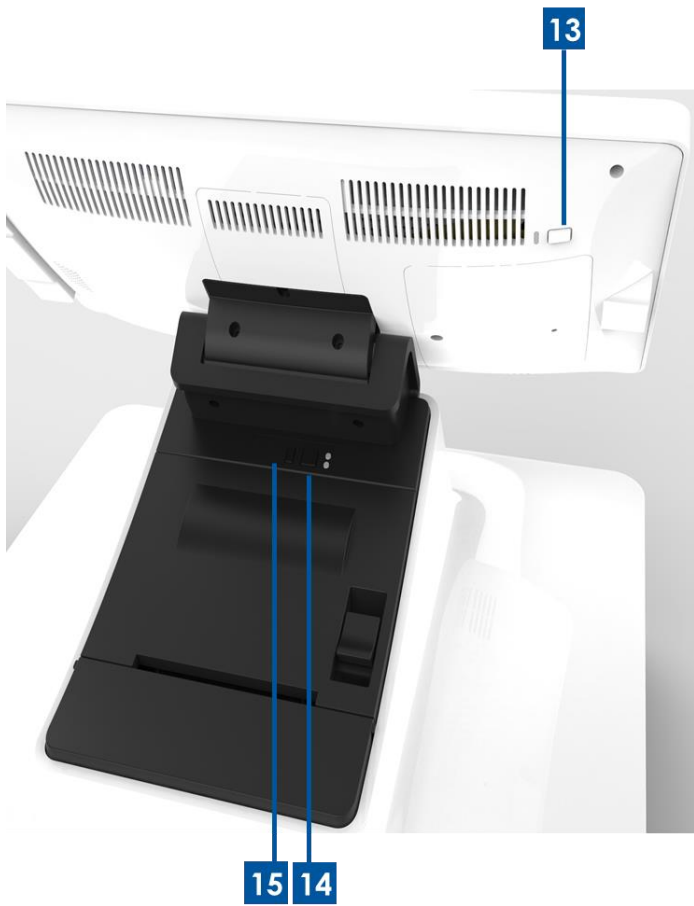

A. PayPoint Plus Display Head

- | | |
|---|--------------------------------|
| 1 | Magnetic Stripe Reader (MSR) |
| 2 | Touch display |
| 3 | Barcode scanner |
| 4 | Barcode scanner manual trigger |
| 5 | Memory/SSD Door |
| 6 | Speaker |

B. PayPoint Plus Base

7	USB Port	16	AC power Input
8	Cash Drawer	17	Micro HDMI Port
9	Cash Drawer Lock	18	12V USB Port
10	Receipt Printer	19	USB Ports
11	Cash Drawer Media Slot	20	Ethernet Port
12	Printer Head Release Lever	21	RJ12 Cash Drawer Port
13	Power Button	22	2x RJ45 Serial Ports
14	Printer Feed Button		
15	Printer Power Button		

1. Magnetic Stripe Reader (MSR)

The register has a built in encryptable magnetic stripe reader. Application provider is responsible for correctly encrypting the reader. When the register is in cashier-facing view, the MSR will be on the left of the register display head. When register is in customer-facing view, the MSR will be on the right of the register display head.

2. Touch display

The register is equipped with a 15.6" FHD with Multitouch TouchPro Pro-G (glass) PCAP touch display.

3. Barcode scanner

The register has a built-in barcode scanner that scans 1-D and 2-D barcodes. When the register is in cashier-facing view, the barcode scanner will be on the right of the register display head.

4. Barcode scanner manual trigger

The back of the display head has a manual trigger for the barcode scanner. It can be accessed with a pin or paper clip.

5. Memory/SSD Door

Remove memory/SSD door to access the memory and SSD storage device for expandable.

6. Speaker

The register has a built in speaker on the back of the display head.

7. USB Port (USB 2.0)

This USB port can be used to connect other point of sale peripheral devices.

8. Cash Drawer

The register is equipped with a cash drawer for storing cash, coins, and checks.

9. Cash Drawer Lock

Use the key that comes with the Elo PayPoint Plus register to lock / unlock the cash register. When cash drawer is locked, cash drawer will not open even when it is commanded to.

Note: Your register comes with one of three unique key and lock combinations. A key and lock pair are marked with matching numbers (001, 002, or 003).

10. Receipt Printer (built-in)

The register is equipped with a built-in receipt printer that is located on the register base.

11. Cash Drawer Media Slot

The cash drawer is designed with a slot for slipping checks into the cash drawer.

12. Printer Head Release Lever

Pull this release lever to release the printer head cover. For more information on how to change printer paper on the register, refer to the Receipt Printer section of this manual.

13. Power Button

The register has a power button on the back of the display head. A short press will turn off the LCD backlight. A long press will automatically power down the PayPoint Plus.

14. Printer Feed Button

Press the printer feed button to feed paper through the PayPoint Plus printer.

15. Printer Power Button

Press the printer power button to power off (and to turn back on) the PayPoint Plus printer. Printer will print printer diagnostics information when printer power button is pressed and held during printer bootup / power on.

16. AC Power In

The PayPoint Plus has a built-in power supply. Plug in the AC power cable provided. The unit can be powered by 110V-240V output

17. Micro HDMI Port

The PayPoint Plus has a built-in micro HDMI port to support Elo Monitors for customer displays.

18. 12V Powered USB Port

The PayPoint Plus has a 12V powered USB port that can provide power (and touch interface) to an external Elo monitor.

19. USB Ports

The USB ports can be used for external peripherals or payment devices.

20. Ethernet Port

Connect a LAN cable to the Ethernet port to enable internet.

21. RJ12 Cash Drawer Port

The register is equipped with a secondary cash drawer port. The cash drawer port follows Star Micronics pin out. Please consult your cash drawer user manual to determine which cash drawer cable you will require.

22. 2x RJ45 Serial Ports

The register has two RJ45 serial ports for connecting external peripherals or payment devices.

Register Display Head

The Elo PayPoint Plus register display head can be flipped to allow customers to complete purchase transactions by self-swiping payment cards, and to authorize transactions by signing directly onto the touchscreen.

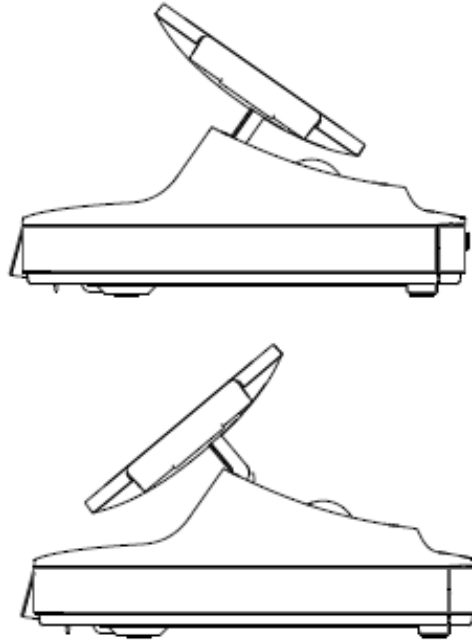

Figure 3. Elo PayPoint Plus display head can be flipped and supports two configurations: Elo PayPoint Plus register cashier-facing view (top) and customer-facing view (bottom)

Power

Press the register power button to turn the Elo PayPoint Plus register on.

In the event that the register freezes and does not respond, press and hold the power button until the register turns off. If the register does not turn off via the power button, the register will need to be powered down by unplugging the power cord from the wall.

The Elo PayPoint Plus register power button is equipped with an LED that indicates the power status of the register, as follows:

Register Power Status	LED Status
OFF (disconnected from wall)	Off
OFF (connected to wall)	Red (Solid)
SLEEP	White (Blinking)
ON	White (Solid)

The system consumes low power when in SLEEP and OFF modes. For detailed power consumption specifications, refer to technical specifications available on the Elo website www.elotouch.com.

To bring register out of sleep/standby mode, press the power button once.

If long periods of non-use are planned, turn off the Elo PayPoint Plus register to save power.

The maximum voltage, frequency and current for the register, are provided in the power ratings table below:

Operating Voltage Range	Operating Frequency Range	Operating Current
100 - 240Vac	50 – 60 Hz	2.5A Max

Recovering the Operating System

If for any reason the touch computer's operating system needs to be recovered to FACTORY SETTINGS, you can recover your system by following the procedures below. **PLEASE NOTE THAT ALL CUSTOMER SETTINGS AND DATA WILL BE LOST DURING THIS PROCESS.** Please be sure to completely backup all of your data, settings, and customer-installed software before proceeding.

1. Power off your system completely.
2. Power on your system.
3. After the Elo splash screen (shown below), press “↑” or “↓” repeatedly to pause on the Windows Boot Manager.



4. Select either **Restore OS 32bit** or **Restore OS 64bit** depending on your OS environment.

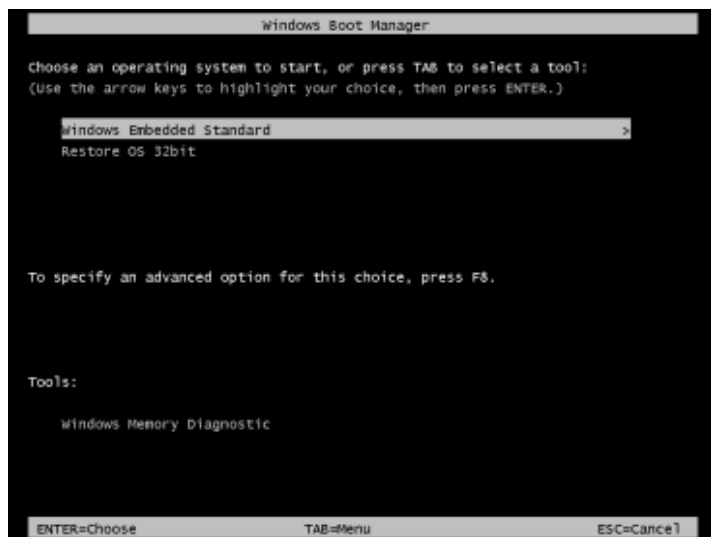

5. The following User Interface (UI) will be presented:

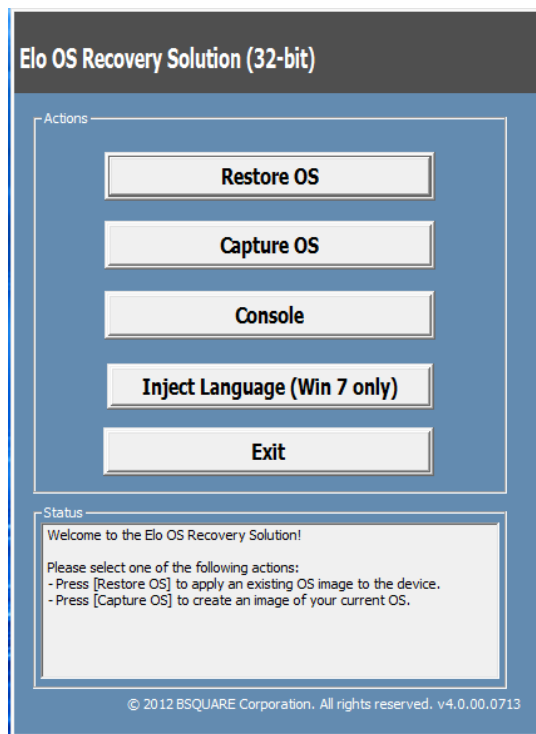

6. Select **Restore OS**. System will test your hardware automatically. Once the process completes, click **Start** button to perform the system recovery function.



7. The following process will reformat the primary hard drive. **Please back up your data before performing the recovery process.**



8. Once completed, click the **Close** button. The system will return to the main menu of the Elo Recovery Solution. Then click the **Exit** button to restart your system.

NOTE: All data is deleted during the recovery process. The user must back up files when necessary. Elo Touch Solutions does not accept liability for lost data or software.

NOTE: The end user must adhere to Microsoft's Licensing Agreement.

Duty Usage Cycle

12 hours on per 24 hours

This will promote power savings, extend life of the display and trouble-free operation throughout the life of the register.

Section 3: Receipt Printer

Printer Paper

The register receipt printer operates using heat, and not with ink. Printer paper compatible with the Elo PayPoint Plus receipt printer are as follows:

Type: Thermal Paper

Paper width: 80 mm (58 mm with paper roll guide installed)

Printing width: 72mm (50.8mm with paper roll guide installed)

Roll Diameter (maximum): 80 mm

Thickness: 0.053 – 0.085 mm

To change the paper for the Elo PayPoint Plus register receipt printer:

1. Ensure that the register display head is flipped away from the receipt printer (in customer-facing view).
2. Pull the receipt printer head release lever to release the printer head cover.
3. Lift printer head cover.
4. Take out the roll of used printer paper and replace with new roll of printer paper. Make sure that the paper is placed and positions in the correct orientation, as shown below.

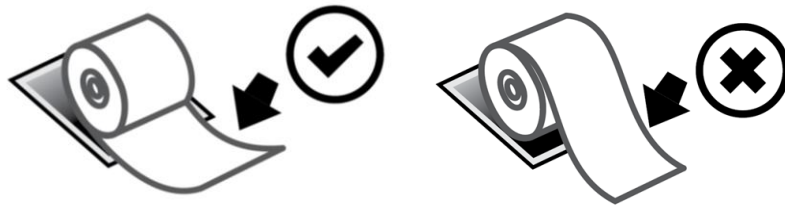

Installing Paper Roll Guide

To operate printer with a 58 mm width receipt paper roll, install paper roll guide as follows:

1. Insert the paper roll guide along the groove of the body
Note: Securely insert into the groove marked with "Δ 58"

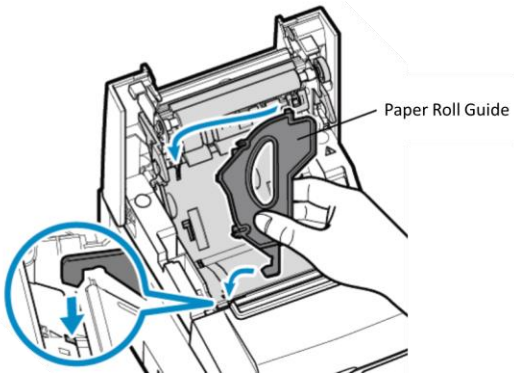

2. Secure the paper roll guide by pressing on it until it clicks in place.

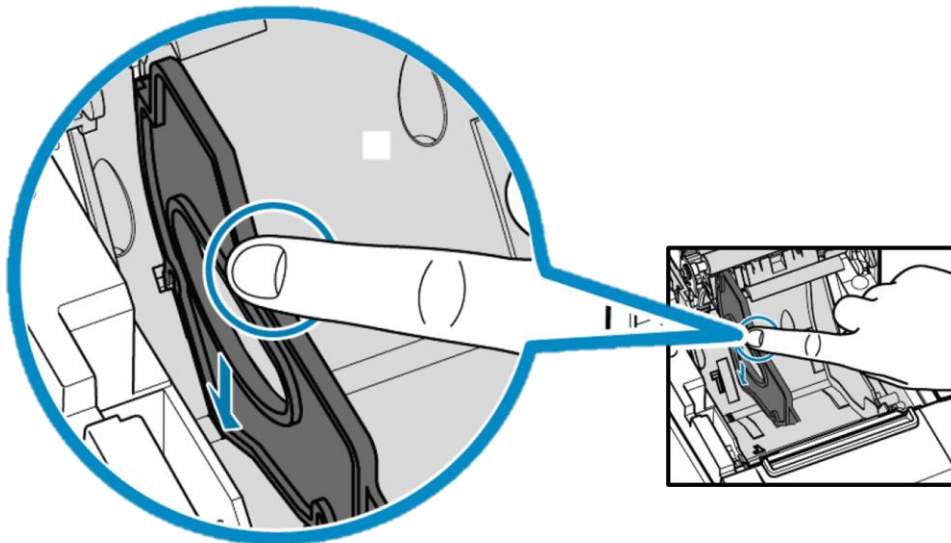

Cleaning and Care of Printer

The following tips will help maintain optimal performance of your Elo PayPoint Plus register receipt printer:

- Do not pull any paper that is ejected from the printer.
- Do not touch the printer roller or thermal head surface with bare hands. In the case of contact between printer roller or thermal head and hands, clean the roller and/or thermal head surface with alcohol, as specified in the latter parts of this section herein.

Note: Contaminating heating elements with any oil or grease (e.g. oil from hands) may shorten the life of the thermal head.

- Turn off printer before performing maintenance on it.

Prior to cleaning the PayPoint Plus register receipt printer, ensure that the register display head is flipped away from the receipt printer (in customer-facing view). Pull the receipt printer head release lever to release printer head cover and access the different printer components listed in Figure 4 above.

Guidance on how to clean the printer photo-sensor, thermal head, and roller are as follows:

1. Roller (Platen)

It is recommendable to clean the printer roller once every 6 months. To do so:

- a. Use a dry, soft cloth, to wipe off any stains from the printer roller.
- b. Clean the entire rubber roller by rotating it.

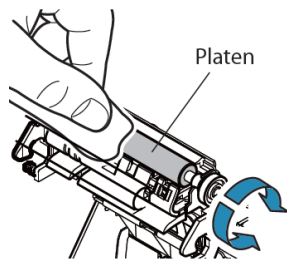

2. Paper holder and its surrounding area:

It is recommendable to clean the paper holder and its surrounding area once every 6 months. To do so:

- a. Use a Nylon brush (or equivalent) to brush off any paper dust or other residues that may have accumulated.

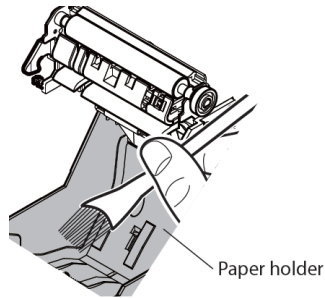

3. Thermal head

It is recommendable to clean the printer thermal head once every 6 months. To do so:

- a. Moist cotton swab (or soft cloth) with alcohol (ethanol, methanol, or isopropyl alcohol).
- b. Wipe the thermal head with the cotton swab to remove any stain from the thermal head.
- c. Use a dry soft cloth to wipe the thermal head.
- d. Wait to allow the thermal head to dry off, and then shut the printer head cover.

Note: Do not clean thermal head immediately after printing, as thermal head may be hot. Be careful of static electricity while cleaning the thermal head. Static electricity can damage the head.

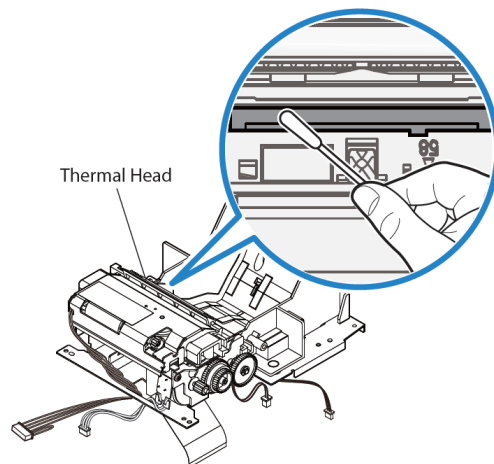

Clearing Paper Jam

In case of paper jam, open the paper jam printer door (highlighted in light gray outline below) to clear paper jam. Open paper jam printer door by exerting upward pressure on side rib (highlighted by blue arrow below). If unable to unlatch door using finger force, use an apparatus (e.g. coin) to gently exert an upward lever force to the side latch.

After removing the paper jam door, rotate the knob to clear the paper jam. Once the paper jam is cleared, replace the paper jam door.



Figure 5. In case of paper jam, exert upward pressure on side rib (blue arrow) to open paper jam printer door (light gray)

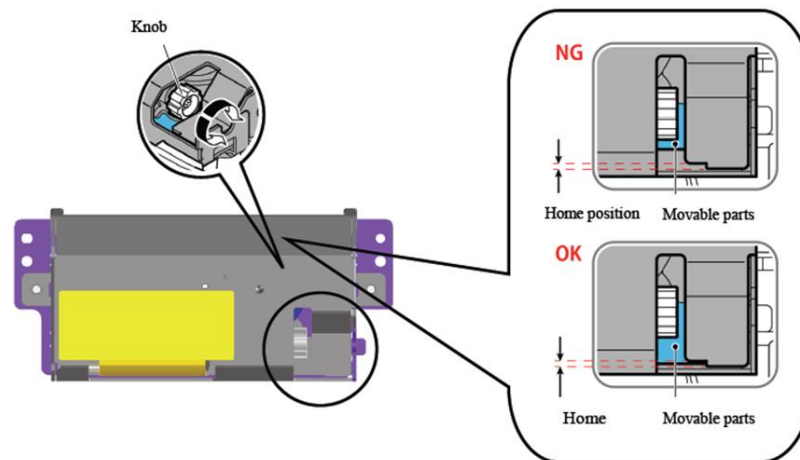

Figure 6. In case of paper jam, rotate the knob to clear the jam.

Section 4: Barcode Scanner

Out-of-Box Settings

Out of the box the default settings of the barcode reader are as follows:

- USB VCP (Virtual COM Port)
- Presentation Mode
 - Illumination always on
- Most common barcodes enabled
- Beep on successful scan

This section covers procedures to set barcode settings and configurations.

Note: Not all available configurations are covered herein. For complete list, refer to N3680 User Guide from www.honeywellaidc.com.

Reader Interface

VCP Mode (Virtual COM Port):



This is the default setting for the scanner out of the box.

USB Keyboard Mode:



USB HID Mode:



Illumination Settings



The above setting is the default for the scanner. The white illumination light will be on at all times.



Scanning the above barcode will disable the white illumination light when the scanner is not in use.

Trigger Mode Settings

Out of the box the default of the scanner will be presentation mode (always on). The reader will be scanning for barcodes at all times.

Manual Trigger mode:



Scanning the above barcode will enable manual trigger mode. When in this mode, the scanner will need to be activated manually (by software or hardware button) between each scan.

Presentation Mode (default setting):



Audio Settings

Out of the box the scanner will be configured to beep on each successful scan of a barcode. This beep can be enabled or disabled based on your preference.

Beep Disable:



Scanning the above barcode will disable the beeper when a barcode is successfully scanned.

Beep Enable:



Scanning the above barcode will enable the beeper when a barcode is successfully scanned.

Keyboard Country Settings

Out of the box the scanner will be configured as US English keyboard

US Keyboard (by default):



Belgium Keyboard:



Canada (French):



Czech Republic:



France (French):



Italy:



KBDCTY5.

Japan:



KBDCTY28.

United Kingdom:



KBDCTY7.

Additional Configurations

Mobile Phone Optimization

Out of the box the scanner will be optimized to read printed barcodes. If the primary application for your scanner will be reading barcodes from mobile devices, the reader can be configured for this purpose.



Reread Delay

If your application requires sometimes rereading of the same barcode, your scanner can be adjusted to allow this. The reader is configured to have a delay between each read of the same barcode to prevent multiple scans of the same item. Use a shorter delay when repetitive barcode scanning is required.

500ms (short delay):



750ms (medium delay):



1 second (long delay):



2 seconds (extra-long delay):



Section 5: Technical Support and Maintenance

Solutions to Common Problems

Problem	Suggested Troubleshooting
The Elo PayPoint Plus register does not respond when turning on the system.	Check that the power cable is properly connected to both the register and the wall. Power button LED will be red when register is properly connected to the wall. OR - Unplug the power cable, re-plug after five seconds, and press the power button to turn on the system. OR - In the case that the power button LED displays solid white light, which suggests that the system is on, there may be an issue with the display or LCD backlight. Please contact Elo Customer Service.
Blank screen	If the power button LED is blinking, the register may be in SLEEP mode. Press the power button to bring the unit out of SLEEP mode.
Receipt printer does not print text on the receipt paper	Ensure that the thermal receipt paper is installed in the printer in the proper orientation. Note: Only one side of the thermal paper is coated with the dye that changes color when heated. This is the side that will need to contact the printer thermal head. Refer to Receipt Paper Section of this manual for more information on how to properly install the thermal receipt paper in the receipt printer. OR - Try and restart the register.
Poor receipt printing quality	Poor receipt printing quality may be due to the use of poor quality thermal paper. Refer to Receipt Printer section of this manual for more information on recommended thermal paper for the Elo PayPoint Plus register receipt printer.
Receipt printer does not run when it's supposed to	Ensure that receipt paper is loaded onto the printer. In case of paper jam, refer to Receipt Printer section of this manual.
MSR does not read card properly	The MSR may not function properly when dirty. Use MSR cleaning cards (purchasable in some office supply stores).
Cash drawer doesn't open	Check to ensure that cash drawer lock is not in lock position. Ensure that the thermal receipt paper is installed in the printer in the proper orientation.

Technical Assistance

Technical Specifications

visit www.elotouch.com/products for technical specifications for this device

Support

visit www.elotouch.com/support for technical support

Refer to last page for worldwide technical support phone numbers.

Elo PayPoint Plus Register Care and Handling

The following tips will help maintain optimal performance of your Elo PayPoint Plus register:

- Disconnect the power cable before cleaning.
- To clean the unit (except for touch screen), use a soft cotton or microfiber cloth lightly dampened with a mild detergent.
- It is important that your unit remains dry. Do not get liquids on or inside the unit. In the event that liquid does get inside, have a qualified service technician inspect the unit before you power it on again.
- Do not wipe the screen with a cloth or sponge that could scratch the surface.
- When cleaning the touchscreen, use window or glass cleaner applied to a clean cloth. Never apply the cleaner directly on the touchscreen. Do not use alcohol (methyl, ethyl or isopropyl), thinner, benzene, or other abrasive cleaners.

Section 6: Regulatory Information

Electrical Safety Information

Compliance is required with respect to the voltage, frequency, and current requirements indicated on the manufacturer's label. Connection to a different power source than those specified herein will likely result in improper operation, damage to the equipment or pose a fire hazard if the limitations are not followed.

There are no operator serviceable parts inside this equipment. There are hazardous voltages generated by this equipment which constitute a safety hazard. Service should be provided only by a qualified service technician.

Contact a qualified electrician or the manufacturer if there are questions about the installation prior to connecting the equipment to mains power.

Emissions and Immunity Information

Notice to Users in the United States for FCC compliance:

This device complies with part 15C of the FCC Rules. Operation is subject to the following two conditions: (1) This device may not cause harmful interference, and (2) this device must accept any interference received, including interference that may cause undesired operation of the device.

Changes or modifications not expressly approved by the party responsible for compliance could void the user's authority to operate the equipment.

NOTE: This equipment has been tested and found to comply with the limits for a Class A digital device, pursuant to Part 15 of the FCC Rules. These limits are designed to provide reasonable protection against harmful interference when the equipment is operated in a commercial environment. This equipment generates, uses, and can radiate radio frequency energy and, if not installed and used in accordance with the instruction manual, may cause harmful interference to radio communications. Operation of this equipment in a residential area is likely to cause harmful interference in which case the user will be required to correct the interference at his own expense.

This equipment should be installed and operated to ensure a minimum of 20 cm spacing to any person.

Notice to Users in Canada for IC compliance:

This equipment complies with the Class A limits for radio noise emissions from digital apparatus as established by the Radio Interference Regulations of Industrial Canada.

CAN ICES3(A)/NMB3(A)

This device complies with Industry Canada's license-exempt RSSs. Operation is subject to the following two conditions:

- (1) This device may not cause interference; and
- (2) This device must accept any interference, including interference that may cause undesired operation of the device.

Le présent appareil est conforme aux CNR d'Industrie Canada applicables aux appareils radio exempts de licence. L'exploitation est autorisée aux deux conditions suivantes:

- (1) l'appareil ne doit pas produire de brouillage, et
- (2) l'utilisateur de l'appareil doit accepter tout brouillage radioélectrique subi, même si le brouillage est susceptible d'en compromettre le fonctionnement.

Notice to Users in the European Union:

Use only the provided power cords and interconnecting cabling provided with the equipment. Substitution of provided cords and cabling may compromise electrical safety or CE Mark Certification for emissions or immunity as required by the following standards:

This Information Technology Equipment (ITE) is required to have a CE Mark on the Manufacturer's label which means that the equipment has been tested to the following Directives and Standards: This equipment has been tested to the requirements for the CE Mark as required by EMC Directive 2014/30/EU as indicated in European Standard EN 55032 Class A and the Low Voltage Directive 2014/35/EU as indicated in European Standard EN 60950-1.

General Information to all Users:

This equipment generates, uses and can radiate radio frequency energy. If not installed and used according to this manual the equipment may cause interference with radio and television communications. There is, however, no guarantee that interference will not occur in any particular installation due to site-specific factors.

1. In order to meet emission and immunity requirements, the user must observe the following:
 - a. Use only the provided I/O cables to connect this digital device with any computer.
 - b. To ensure compliance, use only the provided manufacturer's approved line cord.
 - c. The user is cautioned that changes or modifications to the equipment not expressly approved by the party responsible for compliance could void the user's authority to operate the equipment.

2. If this equipment appears to cause interference with radio or television reception, or any other device:
 - a. Verify as an emission source by turning the equipment off and on. If you determine that this equipment is causing the interference, try to correct the interference by using one or more of the following measures:
 - i. Move the digital device away from the affected receiver.
 - ii. Reposition (turn) the digital device with respect to the affected receiver.
 - iii. Reorient the affected receiver's antenna.
 - iv. Plug the digital device into a different AC outlet so the digital device and the receiver are on different branch circuits.
 - v. Disconnect and remove any I/O cables that the digital device does not use. (Unterminated I/O cables are a potential source of high RF emission levels.)
 - vi. Plug the digital device into only a grounded outlet receptacle. Do not use AC adapter plugs. (Removing or cutting the line cord ground may increase RF emission levels and may also present a lethal shock hazard to the user.)

If you need additional help, consult your dealer, manufacturer, or an experienced radio or television technician.

Radio Equipment Directive

Elo hereby declares that the radio equipment type, Elo PayPoint Plus, is in compliance with Directive 2014/53/EU. The full text of the EU Declaration of Conformity is available at the following internet address: www.elotouch.com

This device is designed and intended for indoor use only.

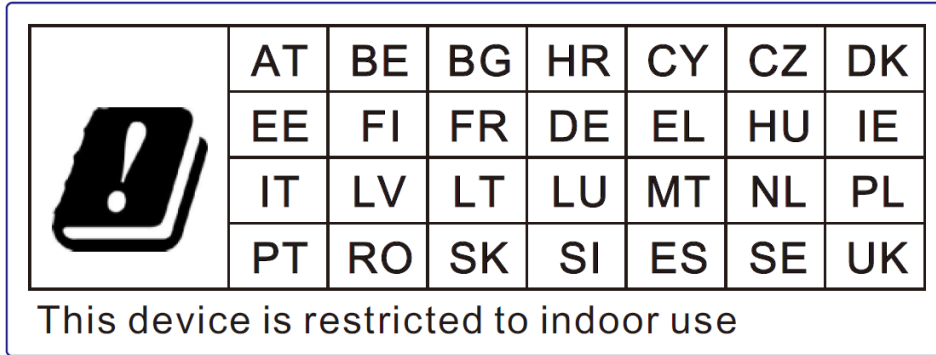

Operation frequency and radio-frequency power are listed as below:

- WLAN 802.11a/b/g/n/ac
 - 2400GHz ≤ 30 dBm EIRP
 - 5150 – 5725GHz ≤ 24 dBm EIRP
 - 5725 – 5850GHz ≤ 30 dBm EIRP
- Bluetooth Tx power
 - BR: 9.5 dBm
 - EDR2/EDR3: 5.5 dBm
 - BLE (LR-125k): 5.0 dBm
 - BLE 1M/2M: 5.5 dBm

ECC/DEC/ (04)08:

The use of the frequency band 5 150-5 350 MHz is restricted to indoor operation because of the protection requirements of satellite services

Agency Certifications

The following certifications and marks have been issued or declared for this peripheral:

- US FCC
- Canada IC
- EU CE
- US and Canada UL/cUL
- International CB
- Japan VCCI
- China CCC
- China SRRC
- Australia RCM

中国 RoHS (China RoHS)

根据中国法律《电器电子产品有害物质限制使用管理办法》，以下部分列出了产品中可能包含的有害物质的名称和含量。

中国电子电气产品环境信息

触控一体机	有害物质					
	铅 (Pb)	汞 (Hg)	镉 (Cd)	六价铬 (Cr(VI))	多溴联 苯 (PBB)	多溴二苯 醚 (PBDE)
电缆组件	X	O	O	O	O	O
玻璃外罩	X	O	O	O	O	O
液晶面板	X	O	O	O	O	O
金属框架	X	O	O	O	O	O
塑胶盖	O	O	O	O	O	O
印制线路板	X	O	O	O	O	O

本表格依据 SJ/T 11364 的规定编制。

O: 表示该有害物质在该部件所有均质材料中的含量均在 GB/T 26572 规定的限量要求以下。

X: 表示该有害物质至少在该部件的某一均质材料中的含量超出 GB/T 26572 规定的限量要求。

标志说明

根据 SJ/T11364 的要求, 电子信息产品标有以下污染控制标识。此产品在 10 年内不会对环境产生影响。



Power Specifications

Electrical Ratings

Input Voltage	100 - 240VAC
Input Current	2.5A

Operating Conditions

Temperature	0°C - 35°C
Humidity	20% to 80% (non-condensing)
Altitude	0 to +10000 ft (3048m)

Storage Conditions

Temperature	-30°C - 60°C
Humidity	5% to 95% (38.7°C max wet bulb temperature)
Altitude	0 to +35000 ft (10668m)

Waste Electrical & Electronic Equipment Directive (WEEE)



This product should not be disposed of with household waste. It should be deposited at a facility that enables recovery and recycling. Elo has put in place recycling arrangements in certain parts of the world. For information on how you can access these arrangements, please visit www.elotouch.com/e-waste-recycling-program/.

Caution:

- Risk of explosion if battery is replaced by an incorrect type.
- Dispose of used battery according to the local laws and regulations.



2 October 2018

FCC Declaration of Conformity

Per FCC 47 CFR FCC Part15 subpart B Section 2.1077(a)
In accordance with FCC Rules and Regulations

Model Number: PayPoint Windows
Equipment Category: Information Technology and Telecommunications Equipment
Equipment Class: Commercial and Light Industrial
Product Name: POS
Manufacturer: Elo Touch Solutions, Inc.
670 N. McCarthy Blvd.
Suite 100
Milpitas, CA 95035
www.elotouch.com

Trademark: 

Declaration:

This device complies with Part 15 of the FCC Rules. Operation is subject to the following two conditions:
(1) This device may not cause harmful interference, and (2) this device must accept any interference received, including interference that may cause undesired operation



Kevin Huang
Director, Systems Engineering
Elo Touch Solutions, Inc.

Section 7: Warranty Information

For warranty information, go to <http://support.elotouch.com/warranty/>

www.elotouch.com

Visit our website for the latest

- Product Information
- Specifications
- Upcoming Events
- Press Releases
- Software Drivers

To find out more about our extensive range of Elo touch solutions, go to www.elotouch.com, or call the office nearest you.

North America

Tel +1 408 597 8000
Fax +1 408 597 8001
elosales.na@elotouch.com

Europe

Tel +32 (0)16 70 45 00
Fax +32 (0)16 70 45 49
elosales@elotouch.com

Asia-Pacific

Tel +86 (21) 3329 1385
Fax +86 (21) 3329 1400
www.elotouch.com.cn

Latin America

Tel +52 55 2281-69581
elosales.latam@elotouch.com

