

ODKS-55

For reference only – drawing subject to change without prior notice

(Fan cooled)

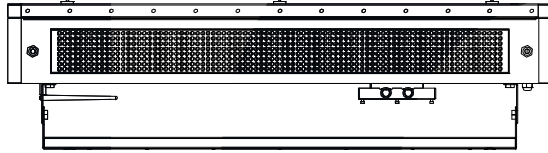

NOTE: Standard fan-cooled case drawing.
Adding peripherals or thermal cooling
will change dimensions of case.

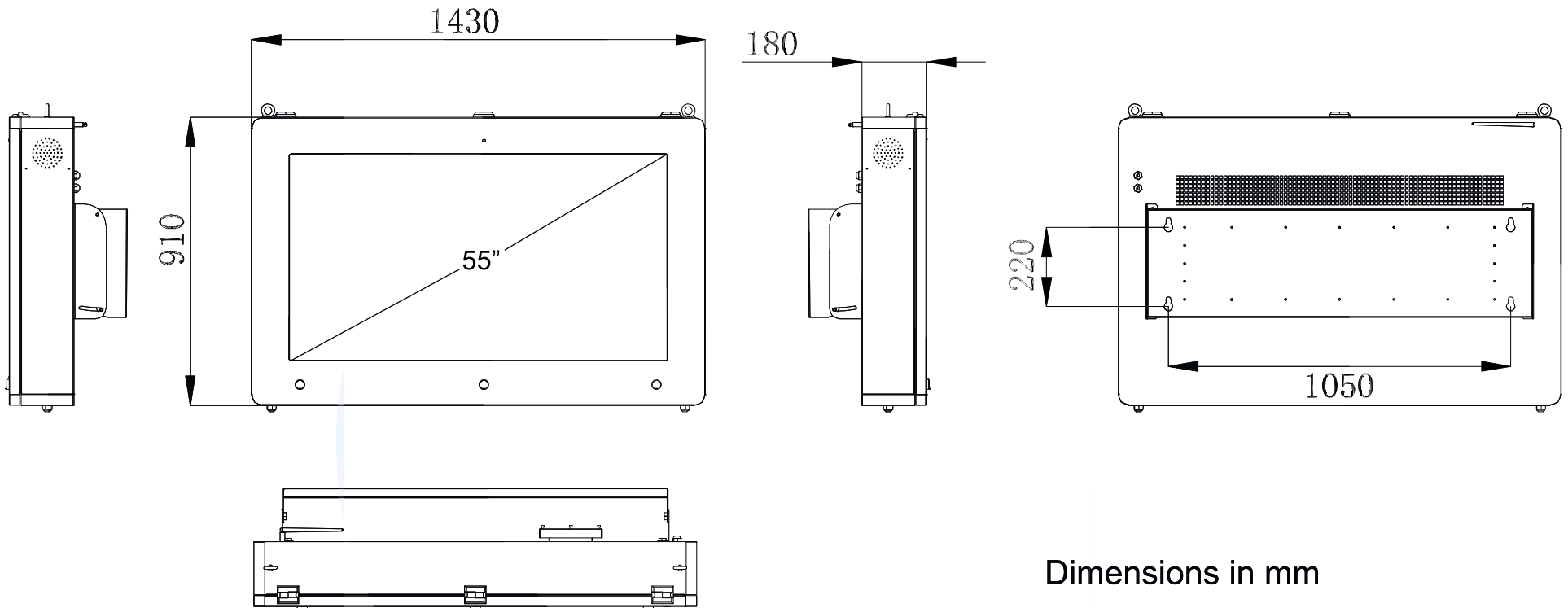

Dimensions in mm